



COOLOR

Superior Restoration Products, Inc.

| | |
|---------------------|---|
| Velour | Velour Repair Products Productos Reparación Velour |
| Leather | Leather Repair Products Productos Reparación Cuero |
| Vinyl | Vinyl Repair Products Productos Reparación Vinilos |
| Dash | Dash Repair Products Productos Reparación Plásticos |
| Color | Coloring Systems Sistemas Color |
| Cleaners | Cleaners, Preps & Removers Limpiadores Especiales |
| Tools | Tools & Equipment Herramientas Especiales |
| Windshield | Windshield Repair Systems Sistema Reparación Parabrisas |
| Dry Fog | Dry Fog Odor System Sistema Desodorante |
| Bright Light | Bright Light Headlight System Sistema Reparación Ópticas |
| Wheels | Wheel Refinishing System Sistema Reparación Llantas |
| Containers | Containers Envases Vacíos |
| Kits | Kits, Systems & Packages Equipos y Sistemas |



| | | | | | | |
|--|-----------|-------------------------------------|-------------------------------------|-------------------------------------|-------------------------------------|-------------------------------------|
| <u>Cleaners & Preps</u> | 4 | <input checked="" type="checkbox"/> | <input type="checkbox"/> | <input type="checkbox"/> | <input type="checkbox"/> | <input type="checkbox"/> |
| <u>Conditioners</u> | 8 | <input checked="" type="checkbox"/> | <input checked="" type="checkbox"/> | <input type="checkbox"/> | <input type="checkbox"/> | <input type="checkbox"/> |
| <u>Odor Conditioners</u> | 10 | <input checked="" type="checkbox"/> | <input checked="" type="checkbox"/> | <input type="checkbox"/> | <input type="checkbox"/> | <input type="checkbox"/> |
| <u>Primers & Promoters</u> | 11 | <input checked="" type="checkbox"/> | <input checked="" type="checkbox"/> | <input checked="" type="checkbox"/> | <input type="checkbox"/> | <input type="checkbox"/> |
| <u>Sealers</u> | 13 | <input checked="" type="checkbox"/> | <input checked="" type="checkbox"/> | <input checked="" type="checkbox"/> | <input checked="" type="checkbox"/> | <input type="checkbox"/> |
| <u>Water Base Pigments</u> | 15 | <input checked="" type="checkbox"/> | <input checked="" type="checkbox"/> | <input checked="" type="checkbox"/> | <input checked="" type="checkbox"/> | <input checked="" type="checkbox"/> |
| <u>Clear Water Bases</u> | 16 | <input type="checkbox"/> | <input checked="" type="checkbox"/> | <input checked="" type="checkbox"/> | <input checked="" type="checkbox"/> | <input checked="" type="checkbox"/> |
| <u>Water Base Premixed Colors</u> | 19 | <input type="checkbox"/> | <input type="checkbox"/> | <input checked="" type="checkbox"/> | <input checked="" type="checkbox"/> | <input checked="" type="checkbox"/> |
| <u>Water Base Additives</u> | 20 | <input type="checkbox"/> | <input type="checkbox"/> | <input type="checkbox"/> | <input checked="" type="checkbox"/> | <input checked="" type="checkbox"/> |
| <u>Dyes & Color Treatment</u> | 23 | <input type="checkbox"/> | <input type="checkbox"/> | <input type="checkbox"/> | <input type="checkbox"/> | <input checked="" type="checkbox"/> |
| <u>Solvent & Lacquer Colors</u> | 25 | <input type="checkbox"/> | <input type="checkbox"/> | <input type="checkbox"/> | <input type="checkbox"/> | <input type="checkbox"/> |
| <u>Clear Lacquer Bases</u> | 27 | <input type="checkbox"/> | <input checked="" type="checkbox"/> | <input type="checkbox"/> | <input type="checkbox"/> | <input type="checkbox"/> |
| <u>Bumper Coaters</u> | 27 | <input type="checkbox"/> | <input checked="" type="checkbox"/> | <input checked="" type="checkbox"/> | <input type="checkbox"/> | <input type="checkbox"/> |
| <u>Solvent & Lacquer Color Additives</u> | 28 | <input type="checkbox"/> | <input checked="" type="checkbox"/> | <input checked="" type="checkbox"/> | <input checked="" type="checkbox"/> | <input type="checkbox"/> |
| <u>Tools & Equipment</u> | 29 | <input type="checkbox"/> | <input type="checkbox"/> | <input checked="" type="checkbox"/> | <input checked="" type="checkbox"/> | <input type="checkbox"/> |
| <u>Containers</u> | 35 | <input type="checkbox"/> | <input type="checkbox"/> | <input type="checkbox"/> | <input checked="" type="checkbox"/> | <input type="checkbox"/> |
| <u>Health & Safety Products</u> | 37 | <input checked="" type="checkbox"/> | <input type="checkbox"/> | <input checked="" type="checkbox"/> | <input type="checkbox"/> | <input type="checkbox"/> |
| <u>Coloring Kits</u> | 39 | <input checked="" type="checkbox"/> | <input type="checkbox"/> | <input checked="" type="checkbox"/> | <input checked="" type="checkbox"/> | <input type="checkbox"/> |
| <u>Toolboxes & Chests</u> | 43 | <input checked="" type="checkbox"/> | <input type="checkbox"/> | <input checked="" type="checkbox"/> | <input checked="" type="checkbox"/> | <input checked="" type="checkbox"/> |
| <u>Product Reference Index</u> | 44 | <input checked="" type="checkbox"/> | <input type="checkbox"/> | <input checked="" type="checkbox"/> | <input type="checkbox"/> | <input checked="" type="checkbox"/> |
| <u>Order Form</u> | 46 | <input checked="" type="checkbox"/> | <input type="checkbox"/> | <input type="checkbox"/> | <input type="checkbox"/> | <input checked="" type="checkbox"/> |

Superior Vinyl & Leather Cleaner ■■■■■ CLEANERS & PREPS

Cleaner used for removing dirt and soils from vinyl, leather and various surfaces.

Features:

- Water Base / Non abrasive
- Fast cleaning / Quick drying
- Non flammable
- Odorless
- Ecologically friendly



Convenient dispensing cap 16 & 32 oz.

| Item | Description | Capacity ounces | Capacity milliliters | Set |
|-------|---|-----------------|----------------------|-----|
| SVC-P | 16 oz Superior Vinyl & Leather Cleaner | 16 fl.oz | 473 ml | 1 |
| SVC-Q | 32 oz Superior Vinyl & Leather Cleaner | 32 fl.oz | 946 ml | 1 |
| SVC-G | 128 oz Superior Vinyl & Leather Cleaner | 128 fl.oz | 3785 ml | 1 |

Z7 Vinyl & Leather Cleaner ■■■■■ CLEANERS & PREPS

Cleaner used for removing dirt and soils from vinyl, leather and various surfaces. Used to prepare surface for repairing and recoloring.

Features:

- Water Base
- Can be diluted with water
- Extra strength



Convenient dispensing cap 16 & 32 oz.

| Item | Description | Capacity ounces | Capacity milliliters | Set |
|------|--------------------------------|-----------------|----------------------|-----|
| Z7-P | 16 oz Vinyl & Leather Cleaner | 16 fl.oz | 473 ml | 1 |
| Z7-Q | 32 oz Vinyl & Leather Cleaner | 32 fl.oz | 946 ml | 1 |
| Z7-G | Gallon Vinyl & Leather Cleaner | 128 fl.oz | 3785 ml | 1 |

Velour & Carpet Spot Remover

■□□□□ CLEANERS & PREPS

Cleaner for removing soils and minor stains from carpet and velour.

Features:

- Water Base product
- Fast cleaning / Quick drying
- Easy application / User friendly
- Odorless
- Ecologically friendly



Color Systems
Sistemas de Color



Convenient dispensing cap

| Item | Description | Capacity ounces | Capacity milliliters | Set |
|--------|------------------------------------|-----------------|----------------------|-----|
| CSR-8 | 8 oz Velour & Carpet Spot Remover | 8 fl.oz | 237 ml | 1 |
| CSR-16 | 16 oz Velour & Carpet Spot Remover | 16 fl.oz | 473 ml | 1 |
| CSR-32 | 32 oz Velour & Carpet Spot Remover | 32 fl.oz | 946 ml | 1 |

Super Clean Plastic Cleaner

■□□□□ CLEANERS & PREPS

Removes mold release agents, wax, grease, tar and other contaminants from plastic and metal.

Features:

- Mineral-free
- No residue
- Fast drying



Ideal Accessory:
465 Preval Sprayer

| Item | Description | Capacity ounces | Capacity milliliters | Set |
|---------|------------------------------------|-----------------|----------------------|-----|
| 1000-A | Aero Super Clean Plastic Cleaner | 19 fl.oz | 562 ml | 1 |
| 1000-16 | 16 oz Super Clean Plastic Cleaner | 16 fl.oz | 473 ml | 1 |
| 1000-4 | 32 oz Super Clean Plastic Cleaner | 32 fl.oz | 946 ml | 1 |
| 1000-1 | 128 oz Super Clean Plastic Cleaner | 128 fl.oz | 3785 ml | 1 |

Silicone Wash ■■■■■ CLEANERS & PREPS

Removes silicone and wax from all surfaces in preparation for repairing and recoloring.

Features:

- Fast drying
- Alcohol base



Ideal accessory:
Drop-by-dop
Dispensing cap
Part # MTR-DR

| Item | Description | Capacity ounces | Capacity milliliters | Set |
|--------|----------------------|-----------------|----------------------|-----|
| S100-P | 16 oz Silicone Wash | 16 fl.oz | 473 ml | 1 |
| S100-Q | 32 oz Silicone Wash | 32 fl.oz | 946 ml | 1 |
| S100-G | Gallon Silicone Wash | 128 fl.oz | 3785 ml | 1 |

Sand Away ■■■■■ CLEANERS & PREPS

Stripper / Cleaner used on leather where stress cracks appear, and on dashes and plastics where the water base coating is peeling.

Features:

- Cleans and restores surface
- Reduces stress cracks



Ideal accessory:
Drop-by-dop
Dispensing cap
Part # MTR-DR

| Item | Description | Capacity ounces | Capacity milliliters | Set |
|------|------------------|-----------------|----------------------|-----|
| SA-8 | 8 oz Sand Away | 8 fl.oz | 237 ml | 1 |
| SA-P | 16 oz Sand Away | 16 fl.oz | 473 ml | 1 |
| SA-Q | 32 oz Sand Away | 32 fl.oz | 946 ml | 1 |
| SA-G | Gallon Sand Away | 128 fl.oz | 3785 ml | 1 |

Superior Leather Prep ■■■■■ CLEANERS & PREPS

Special combination of solvents, that prepare the leather for repair and recoloring.

Features:

- Promotes adhesion
- Opens pores for absorption of color



Color Systems
Sistemas de Color



Reminder:

Safety reminder use gloves
Part# 7005 & 8222

| Item | Description | Capacity ounces | Capacity milliliters | Set |
|-------|------------------------------|-----------------|----------------------|-----|
| SLP-P | 16 oz Superior Leather Prep | 16 fl.oz | 473 ml | 1 |
| SLP-Q | 32 oz Superior Leather Prep | 32 fl.oz | 946 ml | 1 |
| SLP-G | 128 oz Superior Leather Prep | 128 fl.oz | 3785 ml | 1 |

Vinyl & Plastic Prep Solvent ■■■■■ CLEANERS & PREPS

Used for preparing vinyls and plastics before repairing and recoloring.

Features:

- Residue free adhesion
- Softens material for adhesion



Complement:

Paper Towels
HIGH RESISTANCE
Part# 8375 & 8373

| Item | Description | Capacity ounces | Capacity milliliters | Set |
|--------|-------------------------------------|-----------------|----------------------|-----|
| VPPS-P | 16 oz Vinyl & Plastic Prep Solvent | 16 fl.oz | 473 ml | 1 |
| VPPS-Q | 32 oz Vinyl & Plastic Prep Solvent | 32 fl.oz | 946 ml | 1 |
| VPPS-G | Gallon Vinyl & Plastic Prep Solvent | 128 fl.oz | 3785 ml | 1 |

Lexol Leather Cleaner ■■■■■ CLEANERS & PREPS

Cleans leather deeply and safely by removing accumulated dirt and soil.

Features:

- pH balanced to leather
- Ideal for maintenance



1 Apply **Leather Cleaner** to wet cloth or sponge applicator. Apply to one section of a time. Work up foam to lift dirt out of leather.

2 Use clean damp cloth or sponge to rinse leather. Follow with **Leather Conditioner**.

| Item | Description | Capacity ounces | Capacity milliliters | Set |
|-------|--------------------------------|-----------------|----------------------|-----|
| LCL-S | Sampler Lexol Leather Cleaner | 6.76 fl.oz | 200 ml | 1 |
| LCL-½ | ½ Liter Lexol Leather Cleaner | 16.9 fl.oz | 500 ml | 1 |
| LCL-1 | 1 Liter Lexol Leather Cleaner | 33.8 fl.oz | 1000 ml | 1 |
| LCL-3 | 3 Liters Lexol Leather Cleaner | 101.4 fl.oz | 3000 ml | 1 |

Lexol Leather Conditioner ■■■■■ CONDITIONERS

Softens leather, prevents cracking, while restoring the flexibility and natural smoothness.

Features:

- pH adjusted to level of the leather
- Penetrates wet or dry leather



1 Shake well. Apply **Leather Conditioner** to clean cloth or sponge.

2 Apply conditioner over entire cleaned surface.

3 After a few minutes wipe with a clean dry cloth.

| Item | Description | Capacity ounces | Capacity milliliters | Set |
|-------|------------------------------------|-----------------|----------------------|-----|
| LCO-S | Sampler Lexol Leather Conditioner | 6.76 fl.oz | 200 ml | 1 |
| LCO-½ | ½ Liter Lexol Leather Conditioner | 16.9 fl.oz | 500 ml | 1 |
| LCO-1 | 1 Liter Lexol Leather Conditioner | 33.8 fl.oz | 1000 ml | 1 |
| LCO-3 | 3 Liters Lexol Leather Conditioner | 101.4 fl.oz | 3000 ml | 1 |

Leather Cleaner / Conditioner

■■■■■ CONDITIONERS

Cleans and conditions leather in a single application. Optimum results in minutes.

Features:

- Cleans & conditions
- Water Base
- User friendly



Correct application
Set of applicators
Part # 1020

| Item | Description | Capacity ounces | Capacity milliliters | Set |
|-------|--------------------------------------|-----------------|----------------------|-----|
| LCC-8 | 8 oz Leather Cleaner / Conditioner | 8 fl.oz | 237 ml | 1 |
| LCC-P | 16 oz Leather Cleaner / Conditioner | 16 fl.oz | 473 ml | 1 |
| LCC-Q | 32 oz Leather Cleaner / Conditioner | 32 fl.oz | 946 ml | 1 |
| LCC-G | Gallon Leather Cleaner / Conditioner | 128 fl.oz | 3785 ml | 1 |

Color

Color Systems
Sistemas de Color

Creme Leather Conditioner

■■■■■ CONDITIONERS

Conditions and preserves the leather by softening, restoring the flexibility, and smoothness of the most surfaces.

Features:

- Potent moisturizing power
- Immediate results
- Water Base



Complement:
Paper Towel
HIGH RESISTANCE
Part# 8375 & 8373

| Item | Description | Capacity ounces | Capacity milliliters | Set |
|-------|----------------------------------|-----------------|----------------------|-----|
| CLC-8 | 8 oz Creme Leather Conditioner | 8 fl.oz | 237 ml | 1 |
| CLC-P | 16 oz Creme Leather Conditioner | 16 fl.oz | 473 ml | 1 |
| CLC-Q | 32 oz Creme Leather Conditioner | 32 fl.oz | 946 ml | 1 |
| CLC-G | Gallon Creme Leather Conditioner | 128 fl.oz | 3785 ml | 1 |

Leather Smell Conditioner ■■■■■ ODOR CONDITIONERS

Moisturizes the material, while intensifying the original leather scent.

Features:

- Intense leather smell
- Moisturizes
- Non hazardous

| Item | Description | Capacity ounces | Capacity milliliters | Set |
|-------|--------------------------------|-----------------|----------------------|-----|
| LSC-8 | 8 oz Leather Smell Conditioner | 8 fl.oz | 237 ml | 1 |



Odor Fogger ■■■■■ ODOR CONDITIONERS

Deodorizing product used to remove odors while leaving a pleasant fragrance.

Features:

- Various fragrances
- Deodorizing qualities
- Convenient aerosol can

AVAILABLE FRAGRANCES

- Leather
- New Car
- Cherry
- Cinnamon
- Mountain Air

| Item | Description | Capacity ounces | Capacity grams | Set |
|------|--------------------------|-----------------|----------------|-----|
| 202 | 5 oz Aerosol Odor Fogger | 5 fl.oz | 142 gr | 1 |



You will find even more items at www.superiorrestoration.com



Check out our website to discover the most technologically advanced line of products in the industry. Look for our specials, tech tips and much more.

Stay on the cutting edge - don't be left behind!

Water Base High Tac Primer

PRIMERS & PROMOTERS

Primer for leather and vinyl surfaces.

Features:

- Water Base
- Multiple applications
- Promotes adhesion



Convenient dispensing cap

| Item | Description | Capacity ounces | Capacity milliliters | Set |
|--------|-----------------------------------|-----------------|----------------------|-----|
| WBTP-8 | 8 oz Water Base High Tac Primer | 8 fl.oz | 237 ml | 1 |
| WBTP-P | 16 oz Water Base High Tac Primer | 16 fl.oz | 473 ml | 1 |
| WBTP-Q | 32 oz Water Base High Tac Primer | 32 fl.oz | 946 ml | 1 |
| WBTP-G | Gallon Water Base High Tac Primer | 128 fl.oz | 3785 ml | 1 |

Color

Color Systems
Sistemas de Color

Water Base Plastic Primer

PRIMERS & PROMOTERS

Primer for plastic surfaces.

Features:

- Water Base
- Multiple applications
- Promotes adhesion



Ideal accessory:
465 Preval Sprayer

| Item | Description | Capacity ounces | Capacity milliliters | Set |
|------|----------------------------------|-----------------|----------------------|-----|
| PP-8 | 8 oz Water Base Plastic Primer | 8 fl.oz | 237 ml | 1 |
| PP-P | 16 oz Water Base Plastic Primer | 16 fl.oz | 473 ml | 1 |
| PP-Q | 32 oz Water Base Plastic Primer | 32 fl.oz | 946 ml | 1 |
| PP-G | Gallon Water Base Plastic Primer | 128 fl.oz | 3785 ml | 1 |

Flexible Primer Surfacer

PRIMERS & PROMOTERS

Color

**Color Systems
Sistemas de Color**

Gray primer / texture used to fill in minor imperfections before recoloring.

Features:

- Solvent Base
- Quick drying
- Sandable



| Item | Description | Capacity ounces | Capacity milliliters | Set |
|---------|----------------------------------|-----------------|----------------------|-----|
| 39133 | Aerosol Flexible Primer Surfacer | 13 oz | 385 ml | 1 |
| 3000/4 | 4 oz Flexible Primer Surfacer | 4 fl.oz | 118 ml | 1 |
| 3000-16 | 16 oz Flexible Primer Surfacer | 16 fl.oz | 473 ml | 1 |
| 3000-4 | 32 oz Flexible Primer Surfacer | 32 fl.oz | 946 ml | 1 |
| 3000-1 | Gallon Flexible Primer Surfacer | 128 fl.oz | 3785 ml | 1 |



Ideal accessory

Drop by drop dispensing cap
Part # MTR-DR

Plastic Magic

PRIMERS & PROMOTERS

Used for adhesion on all plastics.

Features:

- Solvent Base
- Promotes adhesion
- Various applications



| Item | Description | Capacity ounces | Capacity milliliters | Set |
|--------|-----------------------|-----------------|----------------------|-----|
| 1050-A | Aerosol Plastic Magic | 19 fl.oz | 562 ml | 1 |
| 1050-4 | 32 oz Plastic Magic | 32 fl.oz | 946 ml | 1 |
| 1050-1 | Gallon Plastic Magic | 128 fl.oz | 3785 ml | 1 |



Reminder:

Check out our range of face masks

Superior Leather Sealer ■■■■■ SEALERS

Clear sealer for leather repairs.

Features:

- Solvent Base
- Seals pores
- Promotes adhesion
- Minimizes absorption



Color

Color Systems
Sistemas de Color



Ideal accessory:
465 Preval Sprayer

| Item | Description | Capacity ounces | Capacity milliliters | Set |
|-------|--------------------------------|-----------------|----------------------|-----|
| LS5-6 | 6 oz Superior Leather Sealer | 6 fl.oz | 177 ml | 1 |
| LS5-P | 16 oz Superior Leather Sealer | 16 fl.oz | 473 ml | 1 |
| LS5-Q | 32 oz Superior Leather Sealer | 32 fl.oz | 946 ml | 1 |
| LS5-G | Gallon Superior Leather Sealer | 128 fl.oz | 3785 ml | 1 |

Barrier Coat ■■■■■ SEALERS

Used to improve resistance of vinyl compound, making a seal between the repair compound and the dyeing process. Also hides “flaws” and “halos” resulting from repair.

Features:

- Solvent Base
- Texturing capabilities
- Clear



Ideal Accessory:

Request information on our Air Brushes

| Item | Description | Capacity ounces | Capacity milliliters | Set |
|------|---------------------|-----------------|----------------------|-----|
| BC-6 | 6 oz Barrier Coat | 6 fl.oz | 177 ml | 1 |
| BC-P | 16 oz Barrier Coat | 16 fl.oz | 473 ml | 1 |
| BC-Q | 32 oz Barrier Coat | 32 fl.oz | 946 ml | 1 |
| BC-G | Gallon Barrier Coat | 128 fl.oz | 3785 ml | 1 |

Flexible Super Sealer ■■■■■ SEALERS

Used to improve resistance of plastic repair process, making a seal between the repairing compounds and the dyeing process.

Features:

- Solvent Base
- Promotes adhesion
- Seals repair process
- Multiple applications



Ideal accessory:
465 Preval Sprayer

| Item | Description | Capacity ounces | Capacity milliliters | Set |
|--------|-------------------------------|-----------------|----------------------|-----|
| 3200-A | Aerosol Flexible Super Sealer | 13 fl.oz | 385 ml | 1 |
| 3250-4 | 32 oz Flexible Super Sealer | 32 fl.oz | 946 ml | 1 |
| 3250-1 | Gallon Flexible Super Sealer | 128 fl.oz | 3785 ml | 1 |

Check out our complete range of toolboxes and chests



Request more information on our toolboxes and chests today. We offer a wide variety of models and sizes.

Used to recolor leather, vinyl, carpet, velour and plastics.

With this line of pigments we offer various types of clear bases to promote adhesion on different substrates.

Features:

- Water Base
- Auto matched colors
- Various sizes



Color Systems
Sistemas de Color

TONER COLORS

| |
|----------------------|
| 101 WHITE |
| 110 BLACK |
| 111 CARBON BLACK |
| 120 BLUE |
| 130 RED |
| 131 TRUE RED |
| 133 FAST RED |
| 136 MAROON |
| 138 RED OXIDE |
| 140 DARK BROWN |
| 145 BROWN |
| 150 LIGHT YELLOW |
| 155 YELLOW |
| 160 YELLOW OXIDE |
| 175 GREEN |
| 180 ORANGE |
| 190 PURPLE |
| 201 SILVER |
| 202 BRILLIANT SILVER |
| 210 GOLD |
| 250 PEARL WHITE |

MATCHED COLORS

WE HAVE A COMPLETE LINE OF AUTO MATCHED, CARPET AND FURNITURE COLORS.

See our color Charts.

AUTOMOBILE MAKES

| | |
|---------------|---------------|
| Acura - Honda | Mazda |
| Audi | Mercedes-Benz |
| BMW | Mercury |
| Buick | Mitsubishi |
| Chevrolet | Nissan |
| Chrysler | Oldsmobile |
| Dodge | Plymouth |
| Ferrari | Pontiac |
| Ford | Porsche |
| GM | Range Rover |
| Hyundai | Rolls Royce |
| Infiniti | Saab |
| Isuzu | Subaru |
| Jaguar | Toyota |
| Lexus | Volvo |
| Lincoln | VW |

* Only available from our warehouse in the USA



| Item | Description | Capacity ounces | Capacity milliliters | Set |
|--------|--------------------------|-----------------|----------------------|-----|
| WBP-4 | 4 oz Water Base Pigment | 4 fl.oz | 118 ml | 1 |
| WBP-8 | 8 oz Water Base Pigment | 8 fl.oz | 237 ml | 1 |
| WBP-16 | 16 oz Water Base Pigment | 16 fl.oz | 473 ml | 1 |
| WBP-32 | 32 oz Water Base Pigment | 32 fl.oz | 946 ml | 1 |

Clear Water Base ■ ■ ■ ■ ■ **CLEAR WATER BASES**

Used with pigments to dye leather, vinyl, carpet, velour and plastics.

Available in: Matte, Satin or High Gloss.

Also available High Wear Topcoat in Matte, Satin or High Gloss.

Features:

- Water Base
- Multiple applications



| Item | Description | Matte | Satin | High Gloss | Capacity ounces | Capacity milliliters | Set |
|-------|-------------------------|-------|-------|------------|-----------------|----------------------|-----|
| CWB-A | Aero Clear Water Base | X | X | X | 12 oz | 340 gr | 1 |
| CWB-8 | 8 oz Clear Water Base | X | X | X | 8 fl.oz | 237 ml | 1 |
| CWB-P | 16 oz Clear Water Base | X | X | X | 16 fl.oz | 473 ml | 1 |
| CWB-Q | 32 oz Clear Water Base | X | X | X | 32 fl.oz | 946 ml | 1 |
| CWB-G | Gallon Clear Water Base | X | X | X | 128 fl.oz | 3785 ml | 1 |

Water Base Low Luster Clear ■ ■ ■ ■ ■ **CLEAR WATER BASES**

Mixes with pigments to have a matte finish.

Can also be sprayed over the finished color to flatten the sheen and give added protection.



| Item | Description | Capacity ounces | Capacity milliliters | Set |
|--------------|---|-----------------|----------------------|-----|
| WB/PC-8 1302 | 8 oz Water Base Premixed Color Low Luster Clear | 8 fl. oz | 237 ml | 1 |
| WB/PC-P 1302 | 16 oz Water Base Premixed Color Low Luster Clear | 16 fl.oz | 473 ml | 1 |
| WB/PC-Q 1302 | 32 oz Water Base Premixed Color Low Luster Clear | 32 fl.oz | 946 ml | 1 |
| WB/PC-G 1302 | Gallon Water Base Premixed Color Low Luster Clear | 128 fl.oz | 3785 ml | 1 |

Water Base High Tac Primer

■ ■ ■ ■ ■ CLEAR WATER BASES

Clear Base leather primer can be mixed with pigments to give optimal adhesion on leather.

Features:

- Special leather formulation
- Water Base
- Used on oily surfaces



Convenient dispensing cap

| Item | Description | Capacity ounces | Capacity milliliters | Set |
|--------|-----------------------------------|-----------------|----------------------|-----|
| WBTP-8 | 8 oz Water Base High Tac Primer | 8 fl.oz | 237 ml | 1 |
| WBTP-P | 16 oz Water Base High Tac Primer | 16 fl.oz | 473 ml | 1 |
| WBTP-Q | 32 oz Water Base High Tac Primer | 32 fl.oz | 946 ml | 1 |
| WBTP-G | Gallon Water Base High Tac Primer | 128 fl.oz | 3785 ml | 1 |

Color

Color Systems
Sistemas de Color

Water Base Plastic Primer

■ ■ ■ ■ ■ CLEAR WATER BASES

Clear Base plastic primer can be mixed with pigments to give optimal adhesion on plastic.

Features:

- Special plastic formulation
- Water Base
- Non flammable



Reminder:

Check out our complete range of face masks.

| Item | Description | Capacity ounces | Capacity milliliters | Set |
|------|----------------------------------|-----------------|----------------------|-----|
| PP-8 | 8 oz Water Base Plastic Primer | 8 fl.oz | 237 ml | 1 |
| PP-P | 16 oz Water Base Plastic Primer | 16 fl.oz | 473 ml | 1 |
| PP-Q | 32 oz Water Base Plastic Primer | 32 fl.oz | 946 ml | 1 |
| PP-G | Gallon Water Base Plastic Primer | 128 fl.oz | 3785 ml | 1 |

Carpet Dye Base ■■■■■ CLEAR WATER BASES

Clear used to mix with color pigments formulated for optimal penetration of the dye into carpets and fabrics.

Available in:
Clear & Silver

Features:

- Special flexible carpet formulation
- Water Base
- SILVER option to achieve that original sparkle



| Item | Description | Capacity ounces | Capacity milliliters | Set |
|--------------|---------------------------------|-----------------|----------------------|-----|
| CDB-Q CLEAR | 32 oz Carpet Dye Base - Clear | 32 fl.oz | 946 ml | 1 |
| CDB-G CLEAR | Gallon Carpet Dye Base - Clear | 128 fl.oz | 3785 ml | 1 |
| CDB-Q SILVER | 32 oz Carpet Dye Base - Silver | 32 fl.oz | 946 ml | 1 |
| CDB-G SILVER | Gallon Carpet Dye Base - Silver | 128 fl.oz | 3785 ml | 1 |

Furniture Dye Base ■■■■■ CLEAR WATER BASES

Clear base used to mix with color pigments on domestic and commercial furniture.

Features:

- Special furniture formulation
- Water Base
- High resistance to wear and tear
- Maximum adhesion



Masking Tape

| Item | Description | Capacity ounces | Capacity milliliters | Set |
|-------|---------------------------|-----------------|----------------------|-----|
| FDB-Q | 32 oz Furniture Dye Base | 32 fl.oz | 946 ml | 1 |
| FDB-G | Gallon Furniture Dye Base | 128 fl.oz | 3785 ml | 1 |

Premixed dyes used to recolor leather, vinyl, carpet, velour & plastics. Mixture of 20% pigment color and 80% clear water base.

Available in toner colors, to be used with our formulas.

Features:

- Water Base
- Various applications
- User friendly
- Ecologically safe



Color Systems
Sistemas de Color

TONER COLORS

| |
|----------------------|
| 101 WHITE |
| 110 BLACK |
| 111 CARBON BLACK |
| 120 BLUE |
| 130 RED |
| 131 TRUE RED |
| 133 FAST RED |
| 136 MAROON |
| 138 RED OXIDE |
| 140 DARK BROWN |
| 145 BROWN |
| 150 LIGHT YELLOW |
| 155 YELLOW |
| 160 YELLOW OXIDE |
| 175 GREEN |
| 180 ORANGE |
| 190 PURPLE |
| 201 SILVER |
| 202 BRILLIANT SILVER |
| 210 GOLD |
| 250 PEARL WHITE |

TONER COLORS

| |
|---------------------|
| 1501 BLACK |
| 1508 SILVER METALIC |
| 1550 RED OXIDE |
| 1551 FAST YELLOW |
| 1522 FAST RED |
| 1553 FAST BLUE |
| 1554 TINTING WHITE |
| 1556 FAST GREEN |
| 1559 YELLOW OXIDE |

Adjusted pigmentations allow use of the same formulas as with the solvent base dyes.

MATCHED COLORS

WE HAVE A COMPLETE LINE OF AUTO MATCHED, CARPET AND FURNITURE COLORS.

CONSULT OUR COLOR CHARTS.

* Only available from our warehouses in the USA

| Item Automotive | Item Carpet | Item Furniture | Description | Capacity ounces | Capacity milliliters | Set |
|-----------------|-------------|----------------|-----------------------------------|-----------------|----------------------|-----|
| WB/PC-A | CD-A | FD-A | Aerosol Water Base Premixed Color | 12 oz | 340 gr | 1 |
| WB/PC-8 | CD-8 | FD-8 | 8 oz Water Base Premixed Color | 8 fl.oz | 237 ml | 1 |
| WB/PC-P | CD-P | FD-P | 16 oz Water Base Premixed Color | 16 fl.oz | 473 ml | 1 |
| WB/PC-Q | CD-Q | FD-Q | 32 oz Water Base Premixed Color | 32 fl.oz | 946 ml | 1 |
| WB/PC-G | CD-G | FD-G | Gallon Water Base Premixed Color | 128 fl.oz | 3785 ml | 1 |

Water Base Flex Additive ■■■■ WATER BASE ADDITIVES

Used for improving flexibility in our water base products.

Features:

- Water Base
- Increases longevity
- Promotes adhesion
- Applicable with any water base product



| Item | Description | Capacity ounces | Capacity milliliters | Set |
|--------|---------------------------------|-----------------|----------------------|-----|
| WBFA-8 | 8 oz Water Base Flex Additive | 8 fl.oz | 237 ml | 1 |
| WBFA-P | 16 oz Water Base Flex Additive | 16 fl.oz | 473 ml | 1 |
| WBFA-Q | 32 oz Water Base Flex Additive | 32 fl.oz | 946 ml | 1 |
| WBFA-G | Gallon Water Base Flex Additive | 128 fl.oz | 3785 ml | 1 |

Water Base Slip Additive ■■■■ WATER BASE ADDITIVES

| Item | Description | Capacity ounces | Capacity milliliters | Set |
|--------|---------------------------------|-----------------|----------------------|-----|
| WBSA-4 | 4 oz Water Base Slip Additive | 4 fl.oz | 118 ml | 1 |
| WBSA-8 | 8 oz Water Base Slip Additive | 8 fl.oz | 237 ml | 1 |
| WBSA-P | 16 oz Water Base Slip Additive | 16 fl.oz | 473 ml | 1 |
| WBSA-Q | 32 oz Water Base Slip Additive | 32 fl.oz | 946 ml | 1 |
| WBSA-G | Gallon Water Base Slip Additive | 128 fl.oz | 3785 ml | 1 |

Additive used to soften the feel of water base products and coatings. Will leave a smooth finish on leather.

Features:

- Water Base
- Softens finish coating



Water Base Flatner □□□■ **WATER BASE ADDITIVES**

Additive used to flatten the shine of our clear and water base dyes.

Features:

- Water Base
- Concentrated
- Compatible with WB Low Luster



Convenient dispensing cap

| Item | Description | Capacity ounces | Capacity milliliters | Set |
|-------|---------------------------|-----------------|----------------------|-----|
| WBF-8 | 8 oz Water Base Flatner | 8 fl.oz | 237 ml | 1 |
| WBF-P | 16 oz Water Base Flatner | 16 fl.oz | 473 ml | 1 |
| WBF-Q | 32 oz Water Base Flatner | 32 fl.oz | 946 ml | 1 |
| WBF-G | Gallon Water Base Flatner | 128 fl.oz | 3785 ml | 1 |



Color Systems
Sistemas de Color

Water Base Low Luster Clear □□□■ **WATER BASE ADDITIVES**

Used to reduce the shine of water base dyes on leather, vinyl, carpet, velour & plastics.

Features:

- Water Base
- Clear
- Does not alter color
- Use as a topcoat



| Item | Description | Capacity ounces | Capacity milliliters | Set |
|--------------|---|-----------------|----------------------|-----|
| WB/PC-8 1302 | 8 oz Water Base Premixed Color Low Luster Clear | 8 fl. oz | 237 ml | 1 |
| WB/PC-P 1302 | 16 oz Water Base Premixed Color Low Luster Clear | 16 fl.oz | 473 ml | 1 |
| WB/PC-Q 1302 | 32 oz Water Base Premixed Color Low Luster Clear | 32 fl.oz | 946 ml | 1 |
| WB/PC-G 1302 | Gallon Water Base Premixed Color Low Luster Clear | 128 fl.oz | 3785 ml | 1 |

Crosslinker □□□■ ■ WATER BASE ADDITIVES

Additive to strengthen the adhesion of water base products.

Used for leather, vinyl, carpet or plastics.

Features:

- Water Base
- Does not alter color
- Non flammable



| Item | Description | Capacity ounces | Capacity milliliters | Set |
|----------|--------------------|-----------------|----------------------|-----|
| WBA/CR-2 | 2 oz Crosslinker | 2 fl.oz | 59 gr | 1 |
| WBA/CR-4 | 4 oz Crosslinker | 4 fl.oz | 118 gr | 1 |
| WBA/CR-8 | 8 oz Crosslinker | 8 fl.oz | 237 ml | 1 |
| WBA/CR-P | 16 oz Crosslinker | 16 fl.oz | 473 ml | 1 |
| WBA/CR-Q | 32 oz Crosslinker | 32 fl.oz | 946 ml | 1 |
| WBA/CR-G | Gallon Crosslinker | 128 fl.oz | 3785 ml | 1 |

Water Base Resin □□□■ ■ WATER BASE ADDITIVES

Thinner for water base dyes. Improves penetration in porous materials (leather & carpet)

Features:

- Water Base
- Reduces density
- No alterations



| Item | Description | Capacity ounces | Capacity milliliters | Set |
|-------|-------------------------|-----------------|----------------------|-----|
| WBR-8 | 8 oz Water Base Resin | 8 fl.oz | 237 ml | 1 |
| WBR-P | 16 oz Water Base Resin | 16 fl.oz | 473 ml | 1 |
| WBR-Q | 32 oz Water Base Resin | 32 fl.oz | 946 ml | 1 |
| WBR-G | Gallon Water Base Resin | 128 fl.oz | 3785 ml | 1 |

The most technologically advanced product for restoring color in carpets and fabrics. Patented formulas contain a cleaning agent, color intensifier, color balancer, stain protector and colorizing formula.

Gives your interior the original feel and look!

Just mix the product with powder (Part SCCT-P) and 32 oz (946 ml.) of water, and apply.

Features:

- Penetrates
- Economical & environmentally safe
- No masking



Color Systems
Sistemas de Color

COLORS

| | | | | | |
|---|------------------|---|----------------|--|-------------|
|  | 10 - BLACK |  | 20 - BLUE |  | 41 - CAMEL |
|  | 11 - LIGHT GRAY |  | 21 - DARK BLUE |  | 42 - SAND |
|  | 12 - GRAY |  | 30 - RED |  | 43 - YELLOW |
|  | 13 - BLUE GRAY |  | 31 - BURGUNDY |  | 44 - BEIGE |
|  | 14 - SILVER GRAY |  | 40 - BROWN |  | 50 - GREEN |

REPLACEMENT COLORS CAN BE PURCHASED INDIVIDUALLY



Part # SCCT-P

| Item | Description | Capacity ounces | Capacity milliliters | Set |
|---------|----------------------------|-----------------|----------------------|-----|
| SCCT-NK | Carpet Color Treatment Kit | 32 fl.oz x 15 | 946 ml x 15 | 1 |
| SCCT-P | Packet of Refill Color | 32 fl.oz | 946 ml | 1 |

You will find even more items at www.superiorrestoration.com



Check out our website to discover the most technologically advanced line of products in the industry. Look for our specials, tech tips and much more.

Stay on the cutting edge - don't be left behind!

Aniline / Nubuck / Suede Dye □□□□■ DYES & COLOR TREATMENT

Penetrating dye used for aniline, nubuck and suede.

Features:

- Water Base
- Easy color change
- Easy application (wipe or spray)
- No streaking

TONER COLORS

| |
|------------------|
| 101 WHITE |
| 110 BLACK |
| 120 BLUE |
| 130 RED |
| 131 TRUE RED |
| 138 RED OXIDE |
| 150 LIGHT YELLOW |
| 160 YELLOW OXIDE |
| 175 GREEN |
| 180 ORANGE |



MATCHED COLORS

WE HAVE A COMPLETE LINE OF AUTO MATCHED CARPET AND FURNITURE COLORS.

See our color Charts.

* Only available from our warehouses in the USA

| Item | Description | Capacity ounces | Capacity milliliters | Set |
|--------|---|-----------------|----------------------|-----|
| ANPC-8 | 8 oz Aniline / Nubuck / Suede Dye | 8 fl.oz | 237 ml | 1 |
| ANPC-P | 16 oz Aniline / Nubuck / Suede Dye | 16 fl.oz | 473 ml | 1 |
| ANPC-Q | Quart Water Aniline / Nubuck / Suede Dye | 32 fl.oz | 946 ml | 1 |
| ANPC-G | Gallon Water Aniline / Nubuck / Suede Dye | 128 fl.oz | 3785 ml | 1 |

Clear Aniline / Nubuck / Suede Dye □□□□■ DYES & COLOR TREATMENT

Clear water base topcoat used for protecting applied aniline color coats, adding resistance and color protection.

| Item | Description | Capacity ounces | Capacity milliliters | Set |
|-------|---|-----------------|----------------------|-----|
| CAN-8 | 8 oz Clear Aniline / Nubuck / Suede Dye | 8 fl.oz | 237 ml | 1 |
| CAN-P | 16 oz Clear Aniline / Nubuck / Suede Dye | 16 fl.oz | 473 ml | 1 |
| CAN-Q | 32 oz Clear Aniline / Nubuck / Suede Dye | 32 fl.oz | 946 ml | 1 |
| CAN-G | Gallon Clear Aniline / Nubuck / Suede Dye | 128 fl.oz | 3785 ml | 1 |



Superior Color Coat □□□□□ SOLVENT & LACQUER COLORS

Premixed solvent base dyes are ready for direct application on most flexible & rigid plastics, carpet, vinyl & leather. Available in liquid toner colors and a variety of aerosols colors to choose from.

Features:

- Fast drying
- Strong adhesion



Color Systems
Sistemas de Color

TONER COLORS

| |
|------------------|
| 101 WHITE |
| 103 BEIGE |
| 107 GINGER BROWN |
| 108 DARK BROWN |
| 109 SILVER |
| 110 GOLD |
| 111 YELLOW |
| 112 ORANGE |
| 114 DARK RED |
| 115 MAROON |
| 116 BLACK |
| 119 GREEN |
| 124 BLUE |
| 127 YELLOW OXIDE |
| 128 RED OXIDE |

Aerosol SUPERIOR COAT

PERMANENT DYE – WON'T CRACK, SPLIT, PEEL OR LOSSEN – USE TO RESTORE OR CHANGE ORIGINAL COLOR.

COMPLETE RANGE OF PREMIXED COLORS AVAILABLE FOR FINDING A BLENDABLE MATCH.



| Item | Description | Capacity ounces | Capacity milliliters | Set |
|-------|----------------------------|-----------------|----------------------|-----|
| STC-A | Aerosol Superior Color | 11¼ oz | 319 gr | 1 |
| Z-8 | 8 oz Superior Color Coat | 8 fl.oz | 237 ml | 1 |
| Z-P | 16 oz Superior Color Coat | 16 fl.oz | 473 ml | 1 |
| Z-Q | 32 oz Superior Color Coat | 32 fl.oz | 946 ml | 1 |
| Z-G | Gallon Superior Color Coat | 128 fl.oz | 3785 ml | 1 |

Lacquer Base Color Coat use for changing or refreshing color on plastics, carpet, vinyl & leather.

Available in toners for use with automotive formulas and trim codes.

Features:

- Fast drying
- Ready to spray
- Multiple sheens



TONER COLORS

- 1501 BLACK
- 1508 SILVER METALIC
- 1550 RED OXIDE
- 1551 FAST YELLOW
- 1522 FAST RED
- 1553 BLUE
- 1554 WHITE
- 1556 GREEN
- 1559 YELLOW OXIDE

MATCHED COLORS

COMPLETE RANGE OF *COLOR COAT* AEROSOLS THAT ALLOWS A BLENDABLE COLOR MATCH.

CLASSIC COAT. A NEW GENERATION OF AUTO MATCHED DYES FOR CHANGING OR SIMPLY RENOVATING THE COLOR ON MOST VINYL AND LEATHER. THEY ARE AVAILABLE IN 35 FACTORY MATCHED AUTOMOTIVE COLORS.



Adjusted pigmentations allow use of the same formulas as with premixed water base dyes.

| Item * | Price List Code | Description | Capacity ounces | Capacity milliliters | Set |
|-------------|-------------------|----------------------|-----------------|----------------------|-----|
| "Color" -3 | 17003 | Aerosol Classic Coat | 12 oz | 340 gr | 1 |
| "Color" -3 | 15003 | Aerosol Color Coat | 12 oz | 340 gr | 1 |
| "Color" -HP | 1500-HP / 1551-HP | 8 oz Color Coat | 8 fl.oz | 237 ml | 1 |
| "Color" -8 | 15008 / 15518 | 16 oz Color Coat | 16 fl.oz | 473 ml | 1 |
| "Color" -4 | 15004 / 15514 | 32 oz Color Coat | 32 fl.oz | 946 ml | 1 |
| "Color" -1 | 15001 / 15511 | Gallon Color Coat | 128 fl.oz | 3785 ml | 1 |

*Replace "color" for the color code to get the item number. Example: 32 oz of 1550 Red Oxide. Item number is 15504

Clear Color Coat **CLEAR LACQUER BASES**

Clear Base used to change the sheen of finished Color Coating.

Protects color coats while adding abrasion resistance.

Available in: Low Luster, Satin Gloss or High Gloss.



Color Systems
Sistemas de Color

| Item High Gloss | Item Satin Gloss | Item Low Luster | Description | Capacity ounces | Capacity milliliters | Set |
|-----------------|------------------|-----------------|--------------------------|-----------------|----------------------|-----|
| 13003 | 13013 | 13023 | Aerosol Clear Color Coat | 12 oz | 340 gr | 1 |
| 1300-HP | 1301-HP | 1302-HP | 8 oz Clear Color Coat | 8 fl.oz | 237 ml | 1 |
| 13008 | 13018 | 13028 | 16 oz Clear Color Coat | 16 fl.oz | 473 ml | 1 |
| 13004 | 13014 | 13024 | 32 oz Clear Color Coat | 32 fl.oz | 946 ml | 1 |
| 13001 | 13011 | 13021 | Gallon Clear Color Coat | 128 fl.oz | 3785 ml | 1 |

Bumper Coater **BUMPER COATERS**

Lacquer base color formulated to renew original bumper appearance. Excellent adhesion for bumpers and exterior plastics. Full range of black, grey and metallic colors.



Consult our color charts.



| Item | Price List Code | Description | Capacity ounces | Capacity milliliters | Set |
|-----------|-----------------|-----------------------|-----------------|----------------------|-----|
| "Color"-3 | 39103 | Aerosol Bumper Coater | 12 oz | 340 gr | 1 |
| "Color"-8 | 39108 | 16 oz Bumper Coater | 16 fl.oz | 473 ml | 1 |
| "Color"-4 | 39104 | 32 oz Bumper Coater | 32 fl.oz | 946 ml | 1 |
| "Color"-1 | 39101 | Gallon Bumper Coater | 128 fl.oz | 3785 ml | 1 |

Replace "color" for the color code to get the item number. Example: Aerosol of color 3915 Charcoal. The item number is 39153

Solvent Based Flatner ■ ■ ■ ■ ■ **SOLVENT & LACQUER COLOR ADDITIVES**

Color

Color Systems
Sistemas de Color

Additive to flatten the shine of solvent and lacquer base color coat.

Features:

- Quick drying
- Solvent base



Reminder:
Safety reminder
use gloves
Part# 7005 & 8222

| Item | Description | Capacity ounces | Capacity milliliters | Set |
|--------|-----------------------------|-----------------|----------------------|-----|
| 265-HP | 8 oz Solvent Based Flatner | 8 fl.oz | 237 ml | 1 |
| 265-P | 16 oz Solvent Based Flatner | 16 fl.oz | 473 ml | 1 |
| 265-Q | 32 oz Solvent Based Flatner | 32 fl.oz | 946 ml | 1 |

Flex All 2 ■ ■ ■ ■ ■ **SOLVENT & LACQUER COLOR ADDITIVES**

Flexing agent used with solvent and lacquer base products.

Features:

- Increases flexibility
- Improves adhesion



Complement:
Paper Towels
HIGH RESISTANCE
Part# 8375 & 8373

| Item | Description | Capacity ounces | Capacity milliliters | Set |
|---------|-------------------|-----------------|----------------------|-----|
| 3750-8 | 8 oz Flex All 2 | 8 fl.oz | 237 ml | 1 |
| 3750-16 | 16 oz Flex All 2 | 16 fl.oz | 473 ml | 1 |
| 3750-4 | 32 oz Flex All 2 | 32 fl.oz | 946 ml | 1 |
| 3750-1 | Gallon Flex All 2 | 128 fl.oz | 3785 ml | 1 |

Agitators

Manually used for conveniently mixing colors, textures and other various liquids.

Features:

- Allows blending
- Consistent mixture
- Prevents leaking

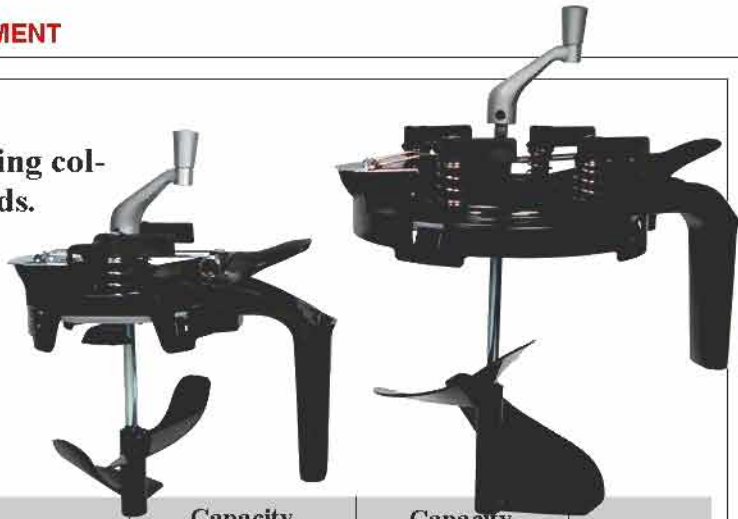

| Item | Description | Capacity ounces Adaptable-jar | Capacity milliliters Adaptable-jar | Set |
|--------|-----------------|----------------------------------|---------------------------------------|-----|
| A127RJ | Quart Agitator | 32 fl.oz | 946 ml | 1 |
| A128RJ | Gallon Agitator | 128 fl.oz | 3785 ml | 1 |

Aerosol Spray Caps



| Item | Description | Set |
|------|------------------------------|-----|
| 5508 | Buttons for Aerosol WB/PC | 1 |
| 5509 | New Button for Aerosol WB/PC | 1 |
| BOB | Aerosol Blow-Out Button | 1 |

Training Manual & DVD

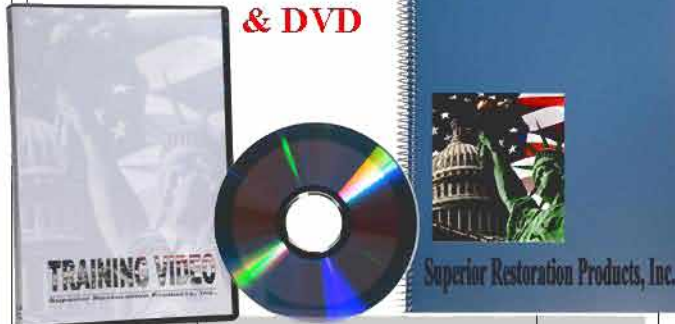

| Item | Description | Set |
|------|-----------------------|-----|
| CTM | Color Matching Manual | 1 |
| CDVD | Color Matching DVD | 1 |

Preval Sprayer

An entirely portable and disposable unit, which combines convenient spraying at the push of a button, with the versatility and economy of a reusable container. These spray tools can be used for the application of texturing products, adhesives and color coats. Also available is the mixing glass jar (466), and 4 oz & 6 oz plastic bottles.

| Item | Description | Set |
|------|-------------------|-----|
| 465 | Preval Power Unit | 1 |



| Part | Description |
|------|-------------------|
| 5507 | Button for Preval |
| 5519 | Preval Tubes |

Color Picker**REDUCES THE MIXING TIME FOR COLORS
INCREASE PRODUCTIVITY**

Due to the enormous range of colors that exist in Automobiles & Furniture, mixing and matching colors is not always easy.

So we have developed this system.

The Color Picker reads the color of the surface directly and gives the formula code needed to dye the part.

This device accounts for the wear and ageing of the original color, and gives you choices of colors to choose from.

Use any of the formulas in our system to obtain the quantity of dye necessary to mix with each basic color.

Formulas with PDA

You just enter the code obtained from the Color Picker and the amount of dye desired.

**Formula Books**

These books included a complete list of formulas, basic advice for mixing and a practical listing of auto manufacturers. Available for lacquer base dyes, water base (pre-mixed) and water base pigments.

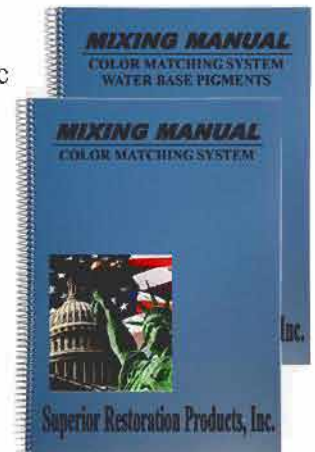
**Features:**

- Various listings
- Easy handling
- Reduces color mixing time
- Reduces unnecessary waste of dyes
- Increase productivity



PRECISION DIGITAL SCALES

Consult our complete range of digital scales.

| Item | Description | Set |
|------|--------------|-----|
| CP | Color Picker | 1 |

PDA with Formulas

Personal Digital Assistant with software including all formulas for dyeing leather, vinyl and plastic parts in autos and furniture. Just enter the color code and the total quantity of dye desired (fig. A), and the screen shows you the detailed information of the pigment water base dyes required for mixing (fig. B).

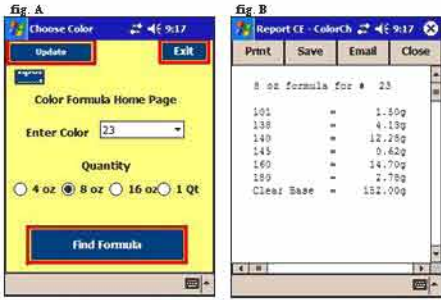

| Item | Description | Set |
|------|----------------------------------|-----|
| PDA | PDA + Storage Card with Formulas | 1 |



Color Systems
Sistemas de Color

Mixing Manuals

Includes formulas for lacquer base, water base and water base pigments.

The formulas include automotive and furniture colors listed by manufacturer trim codes.

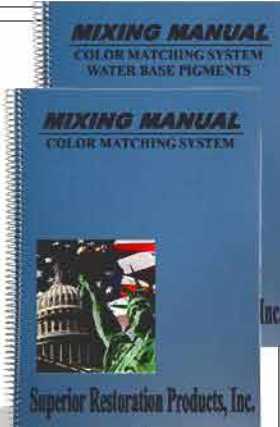

Water Base Color Chart

Listing of colors by automotive make and model. You can order the color ready to spray or mix with our Mixing Manual.

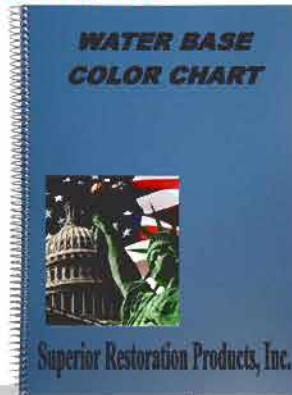

| Item | Description | Set |
|---------|--------------------------------------|-----|
| SMM | Superior Mixing Manual | 1 |
| SMM-WBP | Superior Mixing Manual - WB Pigments | 1 |

| Item | Description | Set |
|------|------------------------|-----|
| WBCH | Water Base Color Chart | 1 |



Color Chart

Choose from the domestic or fleet/foreign automotive

color chart to mix your color by formula.



| Item | Description | Set |
|-------|----------------------|-----|
| 70040 | Domestic Color Decks | 1 |
| FCD | Foreign Color Deck | 1 |

Color Wheel

Guide to understanding color theory when color matching.

Available also in Spanish.

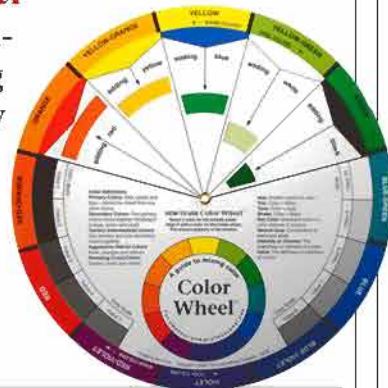

| Item | Description | Set |
|------|-------------|-----|
| CW | Color Wheel | 1 |

Airbrushes

We offer a wide range of spray tools for easy application with paints, adhesives and texturing products. Catalogs available for more choices.

Badger 150-7



Badger 250-4



Badger 350-4



Paasche VL-SET



**Sata MiniJet IV
con Manometer**



**REQUEST MORE INFORMATION
ON ALL OF OUR AVAILABLE MODELS**

Spare Parts and Accessories for Badger Airbrushes

All spare parts and accessories for airbrushes are available.

Hose 5ft & 8ft

50-001 (5 ft = 1,5m)
50-0012 (8 ft = 2,4m)



Compressor Hose

50-2011 (3m)

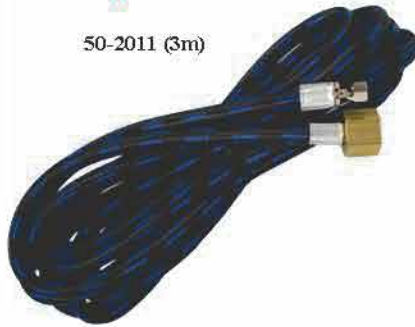

Air Regulator

50-200



Airbrush Body

50-259



Tip & Needles

50-028
Regular (Normal)
50-0281
Large (Grande)



Gaskets

50-0241



50-0242

Syphon Tubes

50-025
50-264

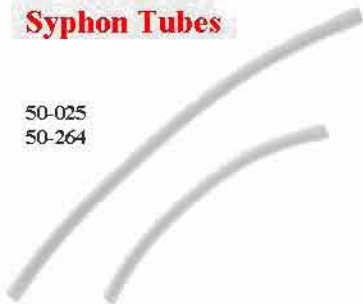

Jar adapter

50-308



Propellant

50-002
(9 oz - 225 gr)

50-202
(15oz - 375 gr)



3/4 oz Jar

50-0052



4 oz Jar

50-267



We offer a complete range of accessories and spare parts for airbrushes and paint guns

Request more information

Color

Color Systems
Sistemas de Color

Digital Scales

Indispensable precision tool for obtaining precise formula calculations when mixing by formula.

Other scales available. Request more information.

CS200 - 200 gr. x 0.1 gr.**SP202 - 200 gr. x 0.01 gr.****CJ600 - 600 gr. x 0.1 gr.**

**CHECK OUT
OUR COMPLETE
& AMPLE
RANGE OF
MODELS**

| Item | Description | Peso Máximo | Precisión | Set |
|-------|--------------------------------------|-------------|-----------|-----|
| CS200 | Ohaus Battery Operated Digital Scale | 200 gr | 0.1 gr | 1 |
| SP202 | Ohaus Battery Operated Digital Scale | 200 gr | 0.01 gr | 1 |
| CJ600 | Battery Operated Digital Scale | 600 gr | 0.1 gr | 1 |



Adapter 110/220 Volt
for CS200

Part 90524-63

You will find even more items at www.superiorrestoration.com



Check out our website to discover the most technologically advanced line of products in the industry. Look for our specials, tech tips and much more.

Stay on the cutting edge - don't be left behind!

Plastic Bottles

Wide selection of sizes.



| Item | Capacity ounces | Capacity milliliters | Set |
|------------|-----------------|----------------------|-----|
| 1/2 PB | 1/2 fl.oz | 15 ml | 1 |
| MT-1 WHITE | 1 fl.oz | 30 ml | 1 |
| MT-2F | 2 fl.oz | 59 ml | 1 |
| MT-4F | 4 fl.oz | 118 ml | 1 |



| Item | Capacity ounces | Capacity milliliters | Set |
|--------|-----------------|----------------------|-----|
| MT-8 | 8 fl.oz | 237 ml | 1 |
| MT-16P | 16 fl.oz | 473 ml | 1 |
| MT-32P | 32 fl.oz | 946 ml | 1 |



Color Systems
Sistemas de Color

Clear Plastic Bottles



| Item | Capacity ounces | Capacity milliliters | Set |
|-----------|-----------------|----------------------|-----|
| PF60 PET | 2 fl.oz | 60 ml | 1 |
| PF100 PET | 3 1/3 fl.oz | 100 ml | 1 |
| PF250 PET | 8 1/2 fl.oz | 250 ml | 1 |

Plastic Lids, Seals and Spray Tops



| Item | Compatible with |
|-----------|------------------|
| MT-1GRTP | MT-1 |
| TWIST CAP | MT-2F MT-4F MT-8 |
| FLIP CAP | ALL except 1/2PB |
| PF LID | PF60 PF100 PF250 |
| SEAL | ALL except 1/2PB |
| MS-L | MT-2F MT-4F MT-8 |
| Q/SP | MT-16P MT-32P |

Color

Color Systems
Sistemas de Color

Metal Containers

| Item | Capacity ounces | Capacity milliliters | Set |
|--------|-----------------|----------------------|-----|
| MT-4R | 4 fl.oz | 118 ml | 1 |
| MT-8R | 8 fl.oz | 237 ml | 1 |
| MT-16R | 16 fl.oz | 473 ml | 1 |
| MT-32R | 32 fl.oz | 946 ml | 1 |



Metal Container Caps



| Item | Compatible with |
|--------|---------------------|
| SEAL | MT-8R MT-16R MT-32R |
| MTR/DR | MT-8R MT-16R MT-32R |
| 5900U | MT-4R MT-16OB |

Plastic Jars



| Item | Capacity ounces | Capacity milliliters | Set |
|------|-----------------|----------------------|-----|
| MT-4 | 4 fl.oz | 118 ml | 1 |
| MT-6 | 6 fl.oz | 177 ml | 1 |

Glass Jars



| Item | Capacity ounces | Capacity milliliters | Set |
|-------|-----------------|----------------------|-----|
| MT-2G | 2 fl.oz | 59 ml | 1 |
| 466 | 6 fl.oz | 177 ml | 1 |

Check out our complete selection of containers

Plastic, Metal & Glass containers & bottles

Jars for Liquids

Jars for Compounds

Dispensing Caps and Droppers

... and much more ...

Ask us for more information today!

Masking Tape

Adhesive paper tape to project undamaged areas.



| Item | Description | Set |
|-------|-----------------------------------|-----|
| 2-T | 2" General Purpose Masking Tape | 1 |
| 3/4-T | 3/4" General Purpose Masking Tape | 1 |

Masking Tape with Plastic

Adhesive tape with plastic sheeting.



| Item | Description | Set |
|---------|--------------------------------|-----|
| PLAS 30 | Masking Tape with 34cm plastic | 1 |
| PLAS 60 | Masking Tape with 60cm plastic | 1 |

Paper Towels

Maximum resistance Disposable towels.



| Item | Description | Set |
|------|--------------------------------|-----|
| 8373 | Box of Paper Towels (31x42 cm) | 160 |
| 8375 | Box of Paper Towels (23x42 cm) | 80 |

Cleaning Brush

Nylon cleaning brushes with or without dispenser.



| Item | Description | Set |
|-------|----------------------------|-----|
| BRD | Nylon Brush with Dispenser | 1 |
| BRUSH | Nylon Brush | 1 |

Gloves

Vinyl or Nitrile Gloves for hand care.

Available in Small, Medium, Large and X-Large sizes.



| Item | Description | Set |
|------|-----------------------|-----|
| 8222 | Box of Vinyl Gloves | 100 |
| 7005 | Box of Nitrile Gloves | 100 |

Safety Goggles



| Item | Description | Set |
|-------|----------------|-----|
| 90412 | Safety Goggles | 1 |



Color Systems
Sistemas de Color

Color

Color Systems
Sistemas de Color

Air Purifying Respirators

Offers protection from contaminants such as organic vapors or particles.

Complies with regulations:

- NIOSH/MSHA (USA)
- EN405:2001 (Europe)



06941



8621

| Item | Description | Set |
|-------|--------------------------|-----|
| 06941 | Air Purifying Respirator | 1 |
| 8621 | Air Purifying Respirator | 1 |

Dust Respirators

Used for protection from non-volatile solid particles.

Complies with regulations:

- NIOSH/MSHA (USA)
- EN149:2001 category FFP2 (Europe)



06922



961710

| Item | Description | Set |
|--------|-------------------------|-----|
| 06922 | Box of Dust Respirators | 10 |
| 961710 | Box of Dust Respirators | 10 |

Face Shield



| Item | Description | Set |
|-------|------------------|-----|
| 90988 | Full Face Shield | 1 |

SAFETY ADVICE

Always wear gloves

Always wear safety glasses

Always use respirators

Follow instructions and precautions indicated on product packaging

Do not use unlabeled products

Your health is vital !!!

Water Base Pigment Coloring Kits

Complete kits in 4 & 8 ounces sizes.

| WBP-K | WBP-SK | PRODUCTS INCLUDED |
|-----------|-----------|------------------------------------|
| WBP-8 101 | WBP-4 101 | Water Base Pigment White |
| WBP-8 110 | WBP-4 110 | Water Base Pigment Black |
| WBP-8 111 | WBP-4 111 | Water Base Pigment Carbon Black |
| WBP-8 120 | WBP-4 120 | Water Base Pigment Blue |
| WBP-8 130 | WBP-4 130 | Water Base Pigment Red |
| WBP-8 131 | WBP-4 131 | Water Base Pigment True Red |
| WBP-8 136 | WBP-4 136 | Water Base Pigment Maroon |
| WBP-8 138 | WBP-4 138 | Water Base Pigment Red Oxide |
| WBP-8 140 | WBP-4 140 | Water Base Pigment Brown |
| WBP-8 145 | WBP-4 145 | Water Base Pigment Dark Brown |
| WBP-8 150 | WBP-4 150 | Water Base Pigment Light Yellow |
| WBP-8 155 | WBP-4 155 | Water Base Pigment Yellow |
| WBP-8 160 | WBP-4 160 | Water Base Pigment Yellow Oxide |
| WBP-8 175 | WBP-4 175 | Water Base Pigment Green |
| WBP-8 180 | WBP-4 180 | Water Base Pigment Orange |
| WBP-8 190 | WBP-4 190 | Water Base Pigment Purple |
| WBP-8 201 | WBP-4 201 | Water Base Pigment Silver |
| CW | CW | Color Wheel |
| CWB-Q x2 | CWB-Q x2 | Clear Water Base - (Satin & Matte) |
| CWB-Q | CWB-P | Clear Water Base High Wear |
| WBTP-Q | WBTP-P | Water Base High Tac Primer |
| PP-Q | PP-P | Water Base Plastic Primer |
| WBF-P | WBF-8 | Water Base Flatner |
| WBFA-P | WBFA-8 | Water Base Flex Additie |
| WBSA-8 | WBSA-4 | Water Base Slip Agent |
| WBA/CR-2 | WBA/CR-2 | Crosslinker |
| CTM | CTM | Color Training Manual |



Color Systems
Sistemas de Color

Request information on all of our systems

- Leather, Vinyl,Plastics & Dash Repair Systems
- Velour & Carpet Repair Systems
- Wheel Refinishing Systems
- Windshield Repair Systems
- Chip Exterior Paint Touch Up Kit
- Dry Fog Odor Systems
- ... and much more ...

**Discover them
and surprise yourself!**

Water Base Premixed Coloring Kits

We offer 3 different sizes for your convenience, 8, 16 & 32 ounces.

| WBCK-Q | WBCK-P | WBCK-8 | PRODUCTS INCLUDED |
|--------------|--------------|--------------|-----------------------------------|
| WB/PC-Q 1501 | WB/PC-P 1501 | WB/PC-8 1501 | Water Base Premixed Landau Black |
| WB/PC-Q 1508 | WB/PC-P 1508 | WB/PC-8 1508 | Water Base Premixed Silver |
| WB/PC-Q 1550 | WB/PC-P 1550 | WB/PC-8 1550 | Water Base Premixed Red Oxide |
| WB/PC-Q 1551 | WB/PC-P 1551 | WB/PC-8 1551 | Water Base Premixed Fast Yellow |
| WB/PC-Q 1552 | WB/PC-P 1552 | WB/PC-8 1552 | Water Base Premixed Fast Red |
| WB/PC-Q 1553 | WB/PC-P 1553 | WB/PC-8 1553 | Water Base Premixed Fast Blue |
| WB/PC-Q 1554 | WB/PC-P 1554 | WB/PC-8 1554 | Water Base Premixed Tinting White |
| WB/PC-Q 1556 | WB/PC-P 1556 | WB/PC-8 1556 | Water Base Premixed Fast Green |
| WB/PC-Q 1559 | WB/PC-P 1559 | WB/PC-8 1559 | Water Base Premixed Yellow Oxide |
| WB/PC-Q 1302 | WB/PC-P 1302 | WB/PC-8 1302 | Water Base Low Luster Clear |
| CWB-P | CWB-8 | CWB-8 | Clear Water Base High Wear |
| WBF-P | WBF-8 | WBF-8 | Water Base Flatner Additive |
| WBFA-P | WBFA-8 | WBFA-8 | Water Base Flex Additive |
| WBSA-8 | WBSA-4 | WBSA-4 | Water Base Slip Additive |
| WBA/CR-2 | WBA/CR-2 | WBA/CR-2 | Crosslinker |
| WBTP-8 | WBTP-8 | WBTP-8 | Water Base High Tac Primer |
| PP-8 | PP-8 | PP-8 | Water Base Plastic Primer |
| CTM | CTM | CTM | Color Training Book |

Lacquer Base Coloring Kits

We offer 3 different sizes for your convenience, 8, 16 & 32 ounces.

| SCK-Q | SCK-P | SCK-HP | PRODUCTS INCLUDED |
|-------|-------|---------|--------------------------|
| 15014 | 15018 | 1501-HP | Color Coat Landau Black |
| 15084 | 15088 | 1508-HP | Color Coat Silver |
| 15504 | 15508 | 1550-HP | Color Coat Red Oxide |
| 15514 | 15518 | 1551-HP | Color Coat Fast Yellow |
| 15524 | 15528 | 1552-HP | Color Coat Fast Red |
| 15534 | 15538 | 1553-HP | Color Coat Fast Blue |
| 15544 | 15548 | 1554-HP | Color Coat Tinting White |
| 15564 | 15568 | 1556-HP | Color Coat Fast Green |
| 15594 | 15598 | 1559-HP | Color Coat Yellow Oxide |
| 13004 | 13008 | 1300-HP | High Gloss Clear |
| 13014 | 13018 | 1301-HP | Satin Gloss Clear |
| 13024 | 13028 | 1302-HP | Low Luster Clear |
| 265-Q | 265-P | 265-HP | Solvent Based Flatner |
| CTM | CTM | CTM | Color Training Manual |

Aerosol Color Kits - Water Base & Solvent Base

Kits include a selection of water base and lacquer base colors. Colors can be substituted by customer.

ACK

| | |
|------------------------|------------------------|
| CWB-A MATE | 13023 Low Luster Clear |
| WB/PC-A 231 Natural | 15033 Saddle Tan |
| WB/PC-A 5083 Black | 15183 Warm Gray |
| WB/PC-A 5084 Gray | 15413 Thomas Gray |
| WB/PC-A 6693 Graphite | 15303 Graphite |
| WB/PC-A 6784 Charcoal | 15243 Black |
| WB/PC-A 6859 Dark Gray | 39073 Silver Metallic |
| WB/PC-A 6918 Agate | 39103 Black |
| WB/PC-A 6988 Graphite | 39153 Charcoal |
| WB/PC-A 7065 Mist Gray | 39163 Medium Smoke |

ACK-S

| | |
|------------------------|------------------------|
| CWB-A MATE | 13023 Low Luster Clear |
| WB/PC-A 5083 Black | 15183 Warm Gray |
| WB/PC-A 6693 Graphite | 15413 Thomas Gray |
| WB/PC-A 6859 Dark Gray | 15243 Black |
| WB/PC-A 6918 Agate | 39103 Black |
| WB/PC-A 7065 Mist Gray | 39163 Medium Smoke |



Color Systems
Sistemas de Color

Aniline Penetrating Dyes

Choose any of the 3 available sizes: 8, 16, or 32 ounces.

AN-K

AN-K16

AN-K8

PRODUCTS INCLUDED

| | | |
|--------------|--------------|--------------|
| ANPC-Q AN101 | ANPC-P AN101 | ANPC-8 AN101 |
| ANPC-Q AN110 | ANPC-P AN110 | ANPC-8 AN110 |
| ANPC-Q AN120 | ANPC-P AN120 | ANPC-8 AN120 |
| ANPC-Q AN130 | ANPC-P AN130 | ANPC-8 AN130 |
| ANPC-Q AN131 | ANPC-P AN131 | ANPC-8 AN131 |
| ANPC-Q AN138 | ANPC-P AN138 | ANPC-8 AN138 |
| ANPC-Q AN150 | ANPC-P AN150 | ANPC-8 AN150 |
| ANPC-Q AN160 | ANPC-P AN160 | ANPC-8 AN160 |
| ANPC-Q AN175 | ANPC-P AN175 | ANPC-8 AN175 |
| ANPC-Q AN180 | ANPC-P AN180 | ANPC-8 AN180 |
| CAN-Q | CAN-P | CAN-8 |
| WBSA-8 | WBSA-4 | WBSA-4 |
| WBA/CR-8 | WBA/CR-4 | WBA/CR-4 |
| SA-Q | SA-P | SA-8 |

| |
|---|
| Water Base Penetrating Dye White |
| Water Base Penetrating Dye Black |
| Water Base Penetrating Dye Blue |
| Water Base Penetrating Dye Red |
| Water Base Penetrating Dye True Red |
| Water Base Penetrating Dye Red Oxide |
| Water Base Penetrating Dye Light Yellow |
| Water Base Penetrating Dye Yellow Oxide |
| Water Base Penetrating Dye Green |
| Water Base Penetrating Dye Orange |
| Penetrating Clear Water Base |
| Water Base Slip Additive |
| Crosslinker |
| Sand Away |

You will find even more items at www.superiorrestoration.com



Check out our website to discover the most technologically advanced line of products in the industry. Look for our specials, tech tips and much more.

Stay on the cutting edge - don't be left behind!

Water Base Carpet Dye Coloring Kits

We offer 2 different size systems for cleaning, removing stains and coloring of the carpets.

| CDQ-K | CDP-K | PRODUCTS INCLUDED |
|-----------|-----------|--|
| CD-Q 1501 | CD-P 1501 | Water Base Carpet Dye Landau Black |
| CD-Q 1508 | CD-P 1508 | Water Base Carpet Dye Silver |
| CD-Q 1550 | CD-P 1550 | Water Base Carpet Dye Red Oxide |
| CD-Q 1551 | CD-P 1551 | Water Base Carpet Dye Fast Yellow |
| CD-Q 1552 | CD-P 1552 | Water Base Carpet Dye Fast Red |
| CD-Q 1553 | CD-P 1553 | Water Base Carpet Dye Fast Blue |
| CD-Q 1554 | CD-P 1554 | Water Base Carpet Dye Tinting White |
| CD-Q 1556 | CD-P 1556 | Water Base Carpet Dye Fast Green |
| CD-Q 1559 | CD-P 1559 | Water Base Carpet Dye Yellow Oxide |
| CD-Q 1302 | CD-P 1302 | Water Base Carpet Dye Low Luster Clear |
| WBSA-8 | WBSA-8 | Water Base Slip Additive |
| WBA/CR-2 | WBA/CR-2 | Crosslinker |
| CSR-32 | CSR-16 | Carpet & Velour Spot Remover |
| RR-8 | RR-4 | Red Relief |
| CFSR-8 | CFSR-4 | Coffee Stain Remover |
| BRUSH | BRUSH | Nylon Brush |
| MT-2F | MT-2F | 2oz Plastic Bottle |
| MS-L | MS-L | Mist Sprayer |

Color Carpet Treatment Kit

The most technologically advanced system to restore the color of carpets. This acid based system cleans, restores and enhances the color while leaving that soft original finish.

| SCCT-K | PRODUCTS INCLUDED | SCCT-K | PRODUCTS INCLUDED |
|--------------|---------------------------------------|------------|----------------------------------|
| SCCT-P 10 x2 | Packet of Color Treatment Black | SCCT-P 41 | Packet of Color Treatment Camel |
| SCCT-P 11 | Packet of Color Treatment Light Gray | SCCT-P 42 | Packet of Color Treatment Sand |
| SCCT-P 12 | Packet of Color Treatment Gray | SCCT-P 44 | Packet of Color Treatment Beige |
| SCCT-P 13 | Packet of Color Treatment Blue Gray | UL2-P | Cleaner "Ultimate Remover" |
| SCCT-P 14 | Packet of Color Treatment Silver Gray | BRUSH | Nylon Brush |
| SCCT-P 20 | Packet of Color Treatment Blue | MT-32P x14 | 32oz Plastic Bottles (15 units) |
| SCCT-P 21 | Packet of Color Treatment Dark Blue | Q/SP x14 | Trigger Sprayer |
| SCCT-P 30 | Packet of Color Treatment Red | BPT-80 | Paper Towels |
| SCCT-P 31 | Packet of Color Treatment Burgundy | 192083 | ProMobile Tool Chest |
| SCCT-P 40 | Packet of Color Treatment Brown | SCCT-M | Training Manual with Color Chart |

Stanley Pro Mobile Tool Chest



Stanley 37" Mobile Job Box



| Item | Description | Set |
|--------|-------------------------------|-----|
| 192083 | Stanley Pro Mobile Tool Chest | 1 |

| Item | Description | Set |
|--------|----------------------------|-----|
| 192790 | Stanley 37" Mobile Job Box | 1 |

16" Multi Purpose Bag



19" ToolBox w/cantilever



19" ToolBox



| Item | Description | Set |
|--------|-----------------------|-----|
| 193327 | 16" Multi Purpose Bag | 1 |

| Item | Description | Set |
|--------|-------------------------|-----|
| 192911 | Tool Box w/2 cantilever | 1 |

| Item | Description | Set |
|--------|-------------|-----|
| 192906 | Tool Box | 1 |



Color Systems
Sistemas de Color

Check out our complete range of toolboxes



Request more information on our toolboxes and chests today. We offer a wide variety of models and sizes.

Product Reference Index

Color

Color Systems
Sistemas de Color

| Item | Page |
|---------|------|
| 202 | 10 |
| 465 | 29 |
| 466 | 36 |
| 5507 | 29 |
| 5508 | 29 |
| 5509 | 29 |
| 5519 | 29 |
| 7005 | 37 |
| 8373 | 37 |
| 8375 | 37 |
| 8621 | 38 |
| 06922 | 38 |
| 06941 | 38 |
| 13001 | 27 |
| 13003 | 27 |
| 13004 | 27 |
| 13008 | 27 |
| 13011 | 27 |
| 13013 | 27 |
| 13014 | 27 |
| 13018 | 27 |
| 13021 | 27 |
| 13023 | 27 |
| 13024 | 27 |
| 13028 | 27 |
| 15001 | 26 |
| 15003 | 26 |
| 15004 | 26 |
| 15008 | 26 |
| 15511 | 26 |
| 15514 | 26 |
| 15518 | 26 |
| 17003 | 26 |
| 39101 | 27 |
| 39103 | 27 |
| 39104 | 27 |
| 39108 | 27 |
| 39133 | 12 |
| 70040 | 31 |
| 90412 | 37 |
| 90988 | 38 |
| 192083 | 43 |
| 192790 | 43 |
| 192906 | 43 |
| 192911 | 43 |
| 193327 | 43 |
| 961710 | 38 |
| 1/2PB | 35 |
| 1000-1 | 5 |
| 1000-16 | 5 |
| 1000-4 | 5 |
| 1000-A | 5 |
| 1050-4 | 12 |
| 1050-A | 12 |
| 1050-G | 12 |

| Item | Page |
|----------|------|
| 1300-HP | 27 |
| 1301-HP | 27 |
| 1302-HP | 27 |
| 1500-HP | 26 |
| 150-7 | 32 |
| 1551-HP | 26 |
| 250-2 | 32 |
| 250-3 | 32 |
| 250-4 | 32 |
| 265-HP | 28 |
| 265-P | 28 |
| 265-Q | 28 |
| 2-T | 37 |
| 3/4-T | 37 |
| 3000/4 | 12 |
| 3000-1 | 12 |
| 3000-16 | 12 |
| 3000-4 | 12 |
| 3200-A | 14 |
| 3250-1 | 14 |
| 3250-4 | 14 |
| 350-4 | 32 |
| 3750-1 | 28 |
| 3750-16 | 28 |
| 3750-4 | 28 |
| 3750-8 | 28 |
| 50-001 | 33 |
| 50-0012 | 33 |
| 50-002 | 33 |
| 50-0052 | 33 |
| 50-0241 | 33 |
| 50-0242 | 33 |
| 50-025 | 33 |
| 50-0281 | 33 |
| 50-200 | 33 |
| 50-2011 | 33 |
| 50-202 | 33 |
| 50-259 | 33 |
| 50-264 | 33 |
| 50-267 | 33 |
| 50-308 | 33 |
| 51-009 | 33 |
| 5900U | 36 |
| 8222-L | 37 |
| 8222-M | 37 |
| 8222-S | 37 |
| 8222-XL | 37 |
| 90524-63 | 34 |
| A127RJ | 29 |
| A128RJ | 29 |
| ACK | 41 |
| ACK-S | 41 |
| AN-K | 41 |
| AN-K16 | 41 |
| AN-K8 | 41 |

| Item | Page |
|----------|----------|
| ANPC-8 | 24 |
| ANPC-G | 24 |
| ANPC-P | 24 |
| ANPC-Q | 24 |
| BC-6 | 13 |
| BC-G | 13 |
| BC-P | 13 |
| BC-Q | 13 |
| BOB | 29 |
| BRUSH | 37 |
| CAN-8 | 24 |
| CAN-G | 24 |
| CAN-P | 24 |
| CAN-Q | 24 |
| CD-A | 19 |
| CDB-G | 18 |
| CDB-Q | 18 |
| CD-G | 19 |
| CD-P | 19 |
| CD-Q | 19 |
| CDP-K | 42 |
| CDQ-K | 42 |
| CDVD | 29 |
| CJ600 | 34 |
| CLC-8 | 9 |
| CLC-G | 9 |
| CLC-P | 9 |
| CLC-Q | 9 |
| CP | 30 |
| CP-CASE | 30 |
| CS200 | 34 |
| CSR-16 | 5 |
| CSR-32 | 5 |
| CSR-8 | 5 |
| CTM | 29 |
| CW | 31 |
| CWB-8 | 16 & 21 |
| CWB-A | 16 & 21 |
| CWB-G | 16 & 21 |
| CWB-P | 16 & 21 |
| CWB-Q | 16 & 21 |
| FCD | 31 |
| FD-A | 19 |
| FDB-G | 18 |
| FDB-Q | 18 |
| FD-G | 19 |
| FD-P | 19 |
| FD-Q | 19 |
| FLIP CAP | FLIP CAP |
| LCC-8 | 9 |
| LCC-G | 9 |
| LCC-P | 9 |
| LCC-Q | 9 |
| LCL-½ | 8 |
| LCL-1 | 8 |

Product Reference Index

| Item | Page | Item | Page | Item | Page |
|------------|---------|--------------|---------|----------|---------|
| LCL-3 | 8 | S100-P | 6 | WBA/CR-P | 22 |
| LCL-S | 8 | S100-Q | 6 | WBA/CR-Q | 22 |
| LCO-½ | 8 | SA-8 | 6 | WBCH | 31 |
| LCO-1 | 8 | SA-G | 6 | WBCK-8 | 40 |
| LCO-3 | 8 | SA-P | 6 | WBCK-P | 40 |
| LCO-S | 8 | SA-Q | 6 | WBCK-Q | 40 |
| LS5-6 | 13 | SCCT-NK | 23 & 42 | WBF-8 | 21 |
| LS5-G | 13 | SCCT-P | 23 | WBFA-8 | 20 |
| LS5-P | 13 | SCK-HP | 40 | WBFA-G | 20 |
| LS5-Q | 13 | SCK-P | 40 | WBFA-P | 20 |
| LSC-8 | 10 | SCK-Q | 40 | WBFA-Q | 20 |
| MINIJET | 32 | SEAL | 35 & 36 | WBF-G | 21 |
| MS-L | 35 | SEAL | 36 | WBF-P | 21 |
| MT-1 WHITE | 35 | SLP-G | 7 | WBF-Q | 21 |
| MT-16P | 35 | SLP-P | 7 | WBP-16 | 15 |
| MT-16R | 36 | SLP-Q | 7 | WBP-32 | 15 |
| MT-1GRTP | 35 | SMM | 31 | WBP-4 | 15 |
| MT-2F | 35 | SMM-WBP | 31 | WBP-8 | 15 |
| MT-2G | 36 | SP202 | 34 | WBP-K | 39 |
| MT-32P | 35 | SUPTECH-A | 25 | WBP-SK | 39 |
| MT-32R | 36 | SVC-G | 4 | WBR-8 | 22 |
| MT-4 | 36 | SVC-P | 4 | WBR-G | 22 |
| MT-4F | 35 | SVC-Q | 4 | WBR-P | 22 |
| MT-4R | 36 | TWIST CAP | 35 | WBR-Q | 22 |
| MT-6 | 36 | VL-SET | 32 | WBSA-4 | 20 |
| MT-8 | 35 | VPPS-G | 7 | WBSA-8 | 20 |
| MT-8R | 36 | VPPS-P | 7 | WBSA-G | 20 |
| MTR/DR | 36 | VPPS-Q | 7 | WBSA-P | 20 |
| PDA | 31 | WB/PC-8 | 19 | WBSA-Q | 20 |
| PF LID | 35 | WB/PC-8 1302 | 16 & 21 | WBTP-8 | 11 & 17 |
| PF100 PET | 35 | WB/PC-A | 19 | WBTP-G | 11 & 17 |
| PF250 PET | 35 | WB/PC-G | 19 | WBTP-P | 11 & 17 |
| PF60 PET | 35 | WB/PC-G 1302 | 16 & 21 | WBTP-Q | 11 & 17 |
| PLAS 30 | 37 | WB/PC-P | 19 | Z7-G | 4 |
| PLAS 60 | 37 | WB/PC-P 1302 | 16 & 21 | Z7-P | 4 |
| PP-8 | 11 & 17 | WB/PC-Q | 19 | Z7-Q | 4 |
| PP-G | 11 & 17 | WB/PC-Q 1302 | 16 & 21 | Z-8 | 25 |
| PP-P | 11 & 17 | WBA/CR-2 | 22 | Z-G | 25 |
| PP-Q | 11 & 17 | WBA/CR-4 | 22 | Z-P | 25 |
| Q/SP | 35 | WBA/CR-8 | 22 | Z-Q | 25 |
| S100-G | 6 | WBA/CR-G | 22 | | |

Price Lists Available

You will find even more items at www.superiorrestoration.com



Check out our website to discover the most technologically advanced line of products in the industry. Look for our specials, tech tips and much more.

Stay on the cutting edge - don't be left behind!

international@superiorrestoration.com

Color

Color Systems
Sistemas de Color

Order Form

Billing Address

Company _____
 Street/Road _____
 ZIP / City _____ Country _____
 Contact Person _____
 Telephone _____ Fax _____
 e-mail _____
 TAX Code _____

Mailing address (only if different)

Company _____
 Street/Road _____
 ZIP / City _____ Country _____
 Telephone _____

Enter customer number if applicable:

Customer Number (appears on your bills)

| Item # | Color | Item Description | Quantity | Unit Price | Total Price |
|--------|-------|------------------|----------|------------|-------------|
| | | | | | |
| | | | | | |
| | | | | | |
| | | | | | |
| | | | | | |
| | | | | | |
| | | | | | |
| | | | | | |
| | | | | | |
| | | | | | |
| | | | | | |
| | | | | | |
| | | | | | |
| | | | | | |
| | | | | | |
| | | | | | |
| | | | | | |
| | | | | | |
| | | | | | |
| | | | | | |
| | | | | | |
| | | | | | |
| | | | | | |

Cash on Delivery

Advanced Bank transfer

Picked up on own account

Payment by credit card

Card # _____ Expiration Date _____

Cardholder Name _____ Signature _____

TOTAL

Shipping charges by weight / volume

+ TAXES if applicable

I hereby accept your billing and supplying conditions

Date _____ Signature and Stamp _____

USA East Coast: FAX +1 954 747 6902

USA West Coast: FAX +1 916 920 5973

Outside USA: FAX +34 935 689 084

We are here to help you

Our support and sales staff

international@superiorrestoration.com



USA

WEST COAST (HEADQUARTERS):

1767 Tribute Road Suite B

SACRAMENTO CA 95815

Tel.: 800-760-9130 · 916-648-6550

Email: superior@superiorrestoration.com

EAST COAST:

4664 North Hiatus Road SUNRISE FL 33351

Tel.: 800-760-0564 · 954-747-6900

Email: eastcoast@superiorrestoration.com

EUROPE

WAREHOUSE CUSTOMER CARE:

Carretera Montmeló, 84

08400 GRANOLLERS – Barcelona - Spain

Tel.: +34.93.568.90.19 Fax: +34.93.568.90.84

E-mail: europe@superiorrestoration.com

We have fully stocked warehouses located throughout the world to expedite the shipping of our customers supply needs.

We offer sea, land and air delivery of our products, according to your needs.

Shipments will be sent from the best geographical location for faster service and to save with shipping costs.

Sales Locations all over the world

For your closest store contact us at
international@superiorrestoration.com

Request information with no obligation.



Superior Restoration Products, Inc.

“The Most Technically Advanced Line of Products in the Automotive Restoration Industry”

www.superiorrestoration.com